

ACCESSORIES

Car Adapter

Enables you to re-charge your battery with your vehicle's electrical system.



Part No. 900507

Battery Cell

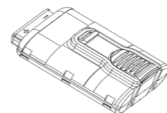

Part No. 018880

Battery Charger

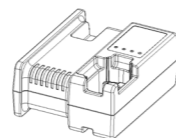

Part No. 018881 (EU)
018882 (UK)

Cable

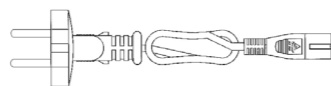

Part No. 018885 (EU)
018886 (UK)

No-Mar Tip - 3 Pk. - Hard Tip

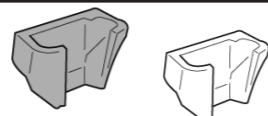

Part No. 901048

No-Mar Tip - 3 Pk. - Soft Tip

Part No. 901067

Special Panelling No-Mar Tip

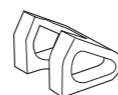

Part No. 012027

Position the nailer for a 45 degree shot

9/64" Hex Key

For cleaning tool

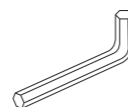

Part No. 900736

Safety Glasses



Part No. 014121

Paslode Intensive Tool Cleaner 300 ml

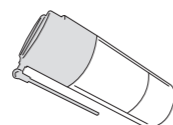

Part No. 115251

Paslode Impulse Lubricating Oil



Part No. 401482

Carrying Case

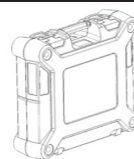

Part No. 014975

Cleaning Kit

Contains all the necessary to clean any Impulse tool

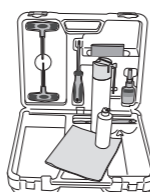

Part No. 013060

Paslode[®]
Impulse[®]

Part No. 013332 (EU)

Part No. 013333 (UK)



IM50 F18 Lithium

IMPORTANT!
DO NOT DESTROY

Always refer to operating and safety instructions (#018909 & #014744) for detailed information on this tool. It is the customer's responsibility to have all operators and service personnel read and understand this information.

TOOL SCHEMATIC AND PARTS



An Illinois Tool Works Company
Route de Lyon - BP 104
F - 26501 Bourg Les Valence - Cedex France

018908-1
07/13

1	013715	1	Grill black	61	901019	1	Torsion Spring Magazine Latch
* 2	900648	1	Filter	62	900353	1	Pivot Pin
3	901064	4	S.H.C.S. 8-32 x 1-3/8"	63	901014	1	Magazine Latch Release
4	900785	1	Spark Plug Sleeve	64	901061	2	Screw 6-32 x 3/16 BH
5	902011	1	Cap black	66	901013	1	Magazine End Cap
6	901119	1	Retaining Ring	67	013671	1	Warning Label Top
8	901382	1	Fan Motor Assembly	68	902416	1	Depth of drive Indicator Label
9	900785	1	Insulator	69	404922	2	Battery Contact Pad
*13	401356	1	Motor Sleeve	70	901095	1	Switch Side Assembly
14	900714	1	Spark Plug Assembly	71	900792	2	Shoulder screw 8-32 x 15/82"
15	900674	1	Wire Clip	73	901084	1	Magazine Wear Strip Assembly
16	900697	1	Stem Adapter	▲ 74	900660	2	Screw 10-32 x 3/8"
■ 17	405140	4	Scfew 8-32 x 7/16" (red)	75	901062	1	Screw 6-32 x 1/8"
18	900596	1	Screw, Sem 8-32 x 7/16"	76	901012	1	Magazine Cover
19	900739	1	Cylinder Head Circuit Board Ass.	77	901015	1	Follower
20	900605	1	Cylinder Head	78	901018	1	Magazine Pin
21	900612	4	Seal Ring	79	901055	1	O-ring
22	900709	1	Fan Assembly	80	901052	1	Spring Cover
23	900700	1	Air Dam	81	901016	1	Constant Force Spring
24	900729	1	Combustion Chamber Assembly	82	901017	1	Spool Spring
25	900746	2	Screw 8-32 x 7/16 phtx	84	903702	1	Handle Left
26	901038	1	Spring	85	903701	1	Handle Right
27	901037	1	Yoke	86	901066	4	Screw- Plastite
28	901039	1	Yoke Support	87	900703	1	Handle Bracket
31	900734	1	Roll Pin	88	900755	1	Bushing Actuator
32	902437	1	Knob W	89	900788	1	Actuator Assembly
34	901009	1	Latch Cover Quick Clear	90	404433	1	Pin Actuator
35	900685	1	Spring Pin	91	900765	1	Spark Plug Wire Assembly
36	901005	1	Latch Clip	92	904562	1	Fan Wire Assembly
37	901049	1	Spring Pin	93	902439	1	Molded Circuit Assembly
38	901006	1	Spring Clip Assembly	*94	901021	1	Piston Bumper
39	901002	1	Front Plate	95	901078	1	Piston Assembly
40	901048	1	Probe Tip	96	901040	1	Piston Ring
41	901007	1	Probe	97	901036	1	Retaining Ring
42	901026	2	Screw 10-24 x .75	98	901044	1	Soft Grip
43	901003	1	Black Plate	99	902440	1	Electronic Spark Unit
44	901025	1	Support Pin	100	900662	1	ESU Power Wire Assembly
45	901004	1	Front Plate Support	101	901045	1	Trigger
46	901081	1	Sleeve Assembly	102	900608	1	Trigger Spring Bushing
47	900616	1	O-Ring	103	901047	1	Trigger Pin
48	901089	1	Exhaust Baffle	104	901053	1	Trigger Spring
49	900665	1	Reed Plate	105	404702	2	Screw 6-32 x 3/8"
50	900664	1	Reed Valve	106	900629	1	High Tension Clip
51	900609	1	Muffler	→107	903003	1	Contact Positive
52	900668	1	Muffler Cover	→108	903004	1	Contact Negative
54	901059	1	Front Channel	109	902434	1	Nut-Utility Hook
55	900598	2	Screw 10-32 x 5/16" (red)	110	902433	1	Button
56	018926	1	Label, Li-Ion IM50 F18	111	902431	1	Block-Utility Hook
57	018929	1	Nameplate	112	902432	1	Spring
58	404385	1	Light Pipe	113	902435	1	Stop Utility Hook
59	018923	1	Handles Label assembly	114	902430	1	Utility Hook

* Indicates normal wear items
 → Denotes Change
 ■ Grease Part No. 900767 to Threads.
 ▲ Apply Loctite RC-620 (Green)

SAFETY INSTRUCTIONS
WEAR EYE AND HEARING PROTECTION



Always wear eye and hearing protection when operating a nail tool.

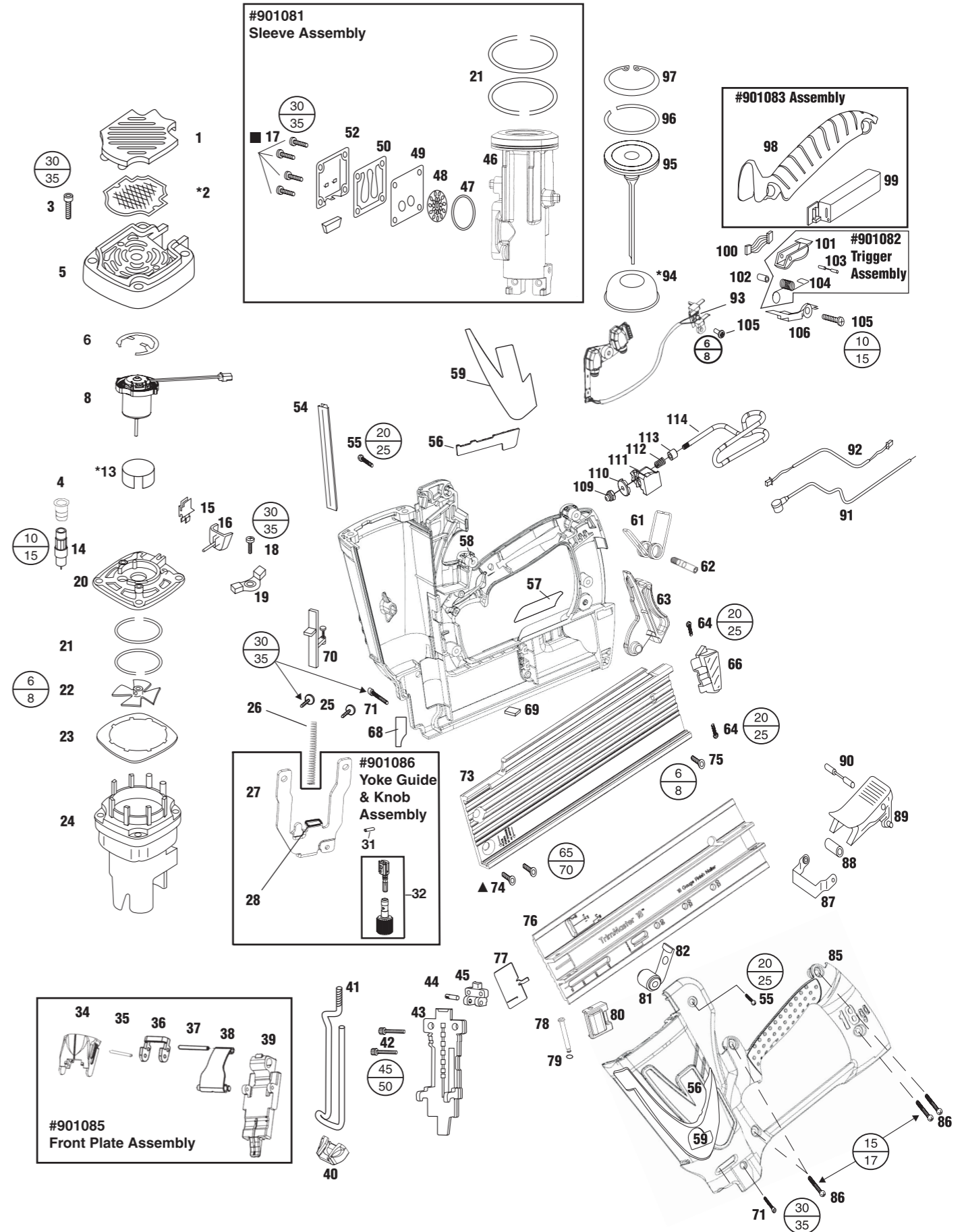

TORQUE VALUES	
MIN	IN.LBS
MAX	

CAUTION
 All parts must be periodically inspected and replaced if worn or broken. Failure to do this can affect the tool's operation and present a safety hazard.